

(19)  
(12)

(KR)  
(S)

(52) L3-639

(45) 2000 09 15  
(11) 30-0263893  
(24) 2000 07 24

---

(21) 30-1999-0019091

(22) 1999 08 11

---

(73)

131-7

(72)

518-3

---

(74)

---

(54)

1.

2.

(water bag)

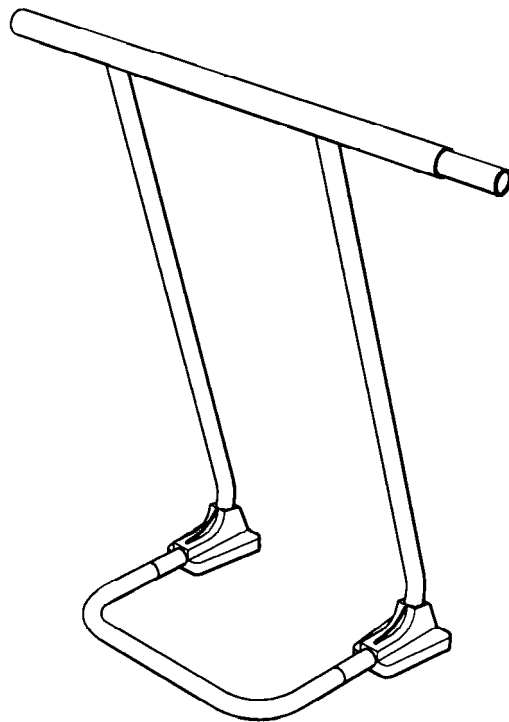

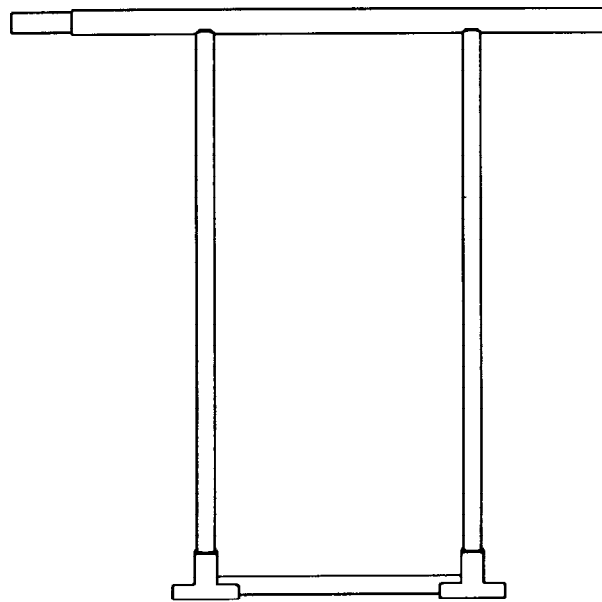
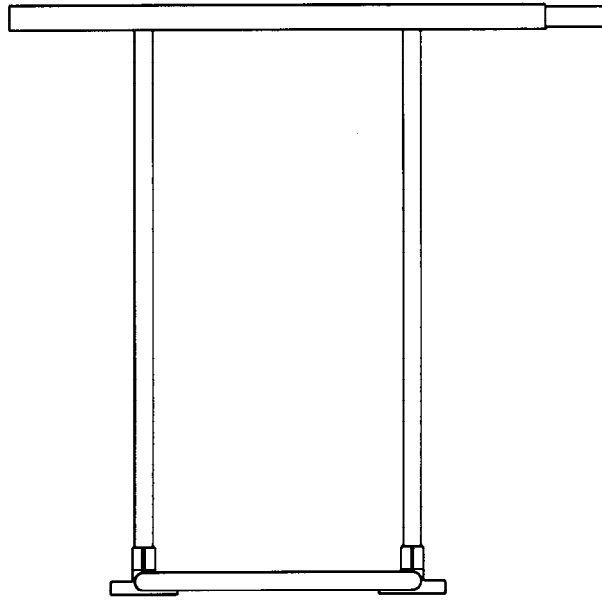

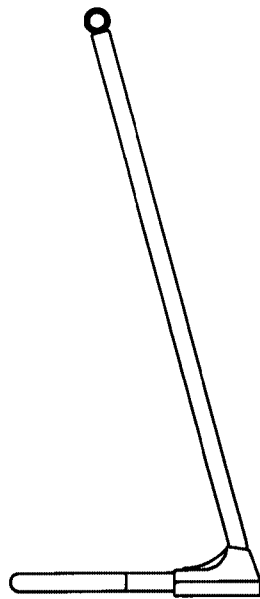
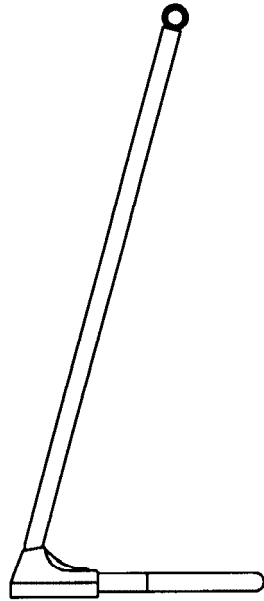

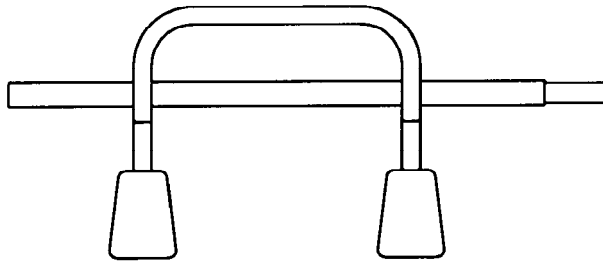
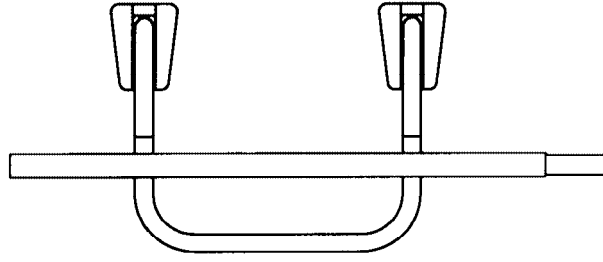

1

